

# Beka® unigy II

Tomorrow's energy systems...today

**MORE POWER  
in LESS SPACE**  
Power Range:  
285 to 1520 A.H.

## AVR95 INTERLOCK™ SYSTEM

**Wider Terminal Plate Spacing**  
improves cable and connection safety.

**Redesigned Air Gap**  
reduces footprint while maintaining required cooling.

**Patented Interlock™ Module** design eliminates rear bolting and allows front access bolting. Increases installation safety.

**AVR95 Cell** delivers 11–28% more power in same space as existing 85 A.H. size. Maintains 20 year design life.

**Front Shield** design easily clips on and off without tools for quicker assembly.

**"Two Way" Post** design eliminates "C" type connectors for easier installation.

**Catalyst Vent** improves high temperature performance.

**Standard Two-Piece Interlock™ Base** meets UBC 97 Zone 3 fault line.  
**Optional One-Piece Interlock™ Base** meets UBC 97 Zone 4 top of building requirements.  
Certified up to eight modules high.



QUALITY SYSTEM  
CERTIFIED TO  
**ISO 9001  
QS 9000**  
Made in U.S.A.

## SYSTEM CONFIGURATIONS

- 48- and 24-volt for Telecommunications
- 120-, 240-, and 480-volt for UPS and Switchgear Control
- New Patented Interlock Modules:
  - 2-cell module: 17 to 33 plate
  - 3-cell module: 17 to 33 plate
  - 4-cell module: 7 to 15 plate
  - 6-cell module: 7 to 15 plate

## FEATURES

- New 48-volt AVR95-33 is reduced by 3.5" in height and 6" in width compared to existing 48-volt AVR85-33 system.
- AVR95-33 is rated at 1520 A.H. at the 8 hour rate compared to the AVR85-33 at 1400 A.H.
- Tank formed plates allow systems to be shipped at 100% rated capacity.

EPM designs meet the requirements of IEC 60896-2, BS 6290 and SR-4228.

## CELL CONSTRUCTION

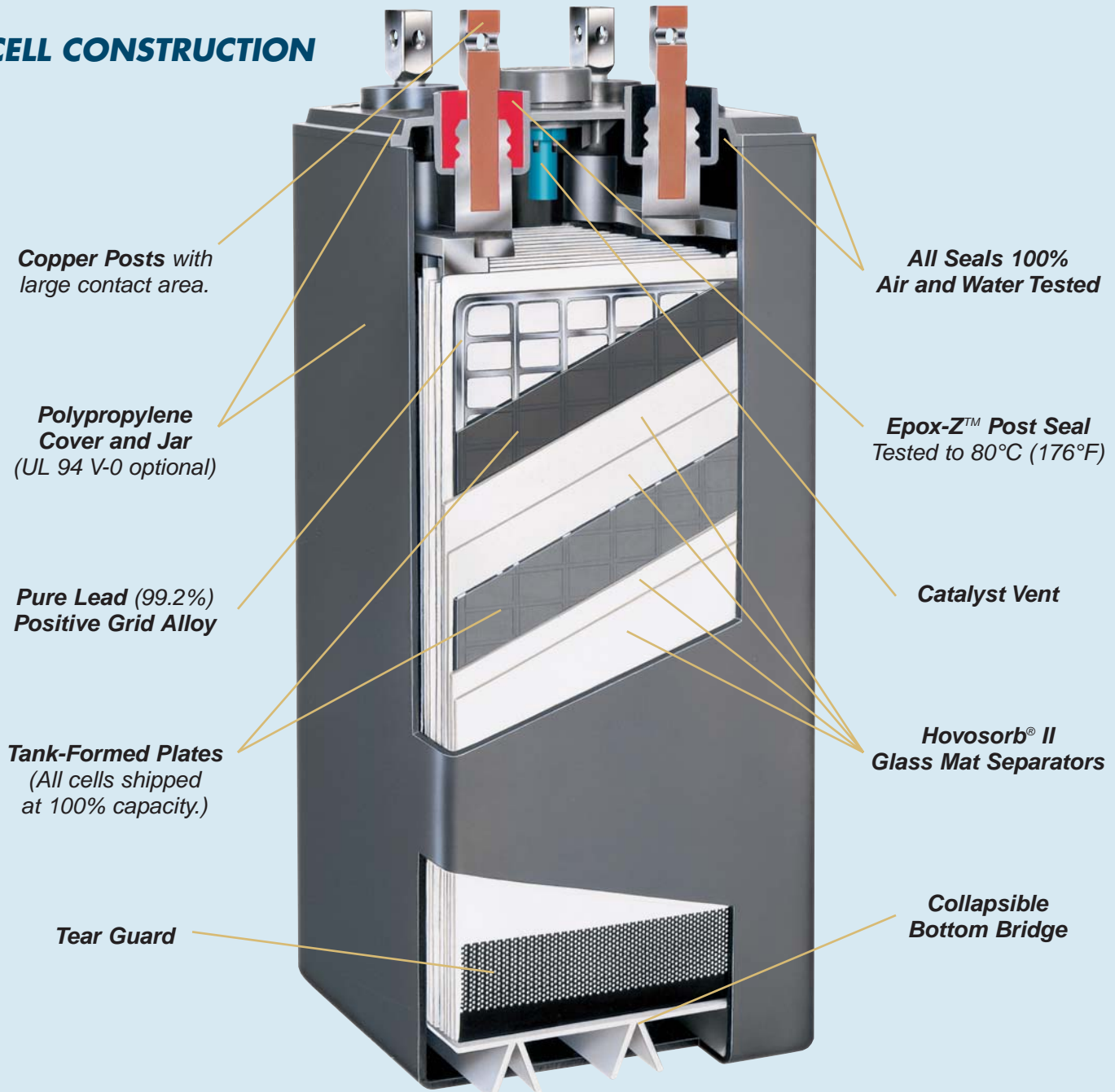

# MODULE DIMENSIONS AND CAPACITIES RANGING FROM 285 TO 1520 A.H.

No. Cells/Module	No. Plates/Cell	Module Number <sup>1</sup>	Module Volts	Capacity C/8 @ 1.75 vpc	Dimensions			
					Length <sup>2</sup> (mm)	Depth <sup>3</sup> (mm)	Height <sup>4</sup> (mm)	Weight <sup>5</sup> (kgs.)
6	7	6AVR95-07	12	<b>285</b>	19.00" (483)	27.12" (689)	9.54" (242)	351 lbs. (159)
	9	6AVR95-09	12	<b>380</b>	23.50" (597)			442 lbs. (200)
	11	6AVR95-11	12	<b>475</b>	28.00" (711)			533 lbs. (242)
	13	6AVR95-13	12	<b>570</b>	32.50" (826)			624 lbs. (283)
	15	6AVR95-15	12	<b>665</b>	37.00" (940)			715 lbs. (324)
4	7	4AVR95-07	8	<b>285</b>	12.66" (322)	27.12" (689)	9.54" (242)	226 lbs. (103)
	9	4AVR95-09	8	<b>380</b>	15.66" (398)			281 lbs. (127)
	11	4AVR95-11	8	<b>475</b>	18.66" (474)			336 lbs. (152)
	13	4AVR95-13	8	<b>570</b>	21.66" (550)			391 lbs. (177)
	15	4AVR95-15	8	<b>665</b>	24.66" (626)			446 lbs. (202)
3	17	3AVR95-17	6	<b>760</b>	21.90" (556)	27.12" (689)	9.54" (242)	419 lbs. (190)
	19	3AVR95-19	6	<b>855</b>	24.15" (613)			465 lbs. (211)
	21	3AVR95-21	6	<b>950</b>	26.40" (671)			510 lbs. (231)
	23	3AVR95-23	6	<b>1045</b>	28.65" (728)			556 lbs. (252)
	25	3AVR95-25	6	<b>1140</b>	30.90" (785)			602 lbs. (273)
	27	3AVR95-27	6	<b>1235</b>	33.15" (842)			644 lbs. (292)
	29	3AVR95-29	6	<b>1330</b>	35.40" (899)			693 lbs. (314)
	31	3AVR95-31	6	<b>1425</b>	37.65" (956)			735 lbs. (333)
2	17	2AVR95-17	4	<b>760</b>	14.60" (371)	27.12" (689)	9.54" (242)	269 lbs. (122)
	19	2AVR95-19	4	<b>855</b>	16.10" (409)			296 lbs. (134)
	21	2AVR95-21	4	<b>950</b>	17.60" (447)			324 lbs. (147)
	23	2AVR95-23	4	<b>1045</b>	19.10" (485)			351 lbs. (159)
	25	2AVR95-25	4	<b>1140</b>	20.60" (523)			378 lbs. (171)
	27	2AVR95-27	4	<b>1235</b>	22.10" (561)			404 lbs. (183)
	29	2AVR95-29	4	<b>1330</b>	23.60" (599)			433 lbs. (196)
	31	2AVR95-31	4	<b>1425</b>	25.10" (638)			459 lbs. (208)
	33	2AVR95-33	4	<b>1520</b>	26.60" (676)	486 lbs. (220)		

<sup>1</sup> Add "S," for **Standard Polypropylene**, or "L" for **Flame Retardant Polypropylene**, suffix to module number. (ex. 6AVR95-07S)

<sup>2</sup> For system length take dimension and multiply by number of stacks. For side termination add additional 6" (3" per side).

<sup>3</sup> Includes front shield. Add additional .75" for one-piece base.

<sup>4</sup> For module stack height, subtract 1.5" from height and multiply by number of modules and then add 1.5." For overall battery height (top termination) add 4" for base, 1.5" for terminal bracket and 6.25" for top shield.

<sup>5</sup> Weight includes module + cells, but not the cell hardware.

**6 Cell  
(7-15 plates)**

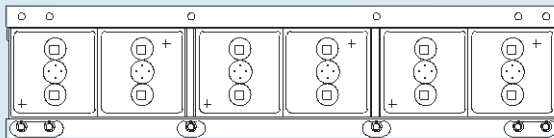

**4 Cell  
(7-15 plates)**

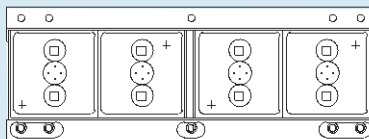

**3 Cell  
(17-33 plates)**

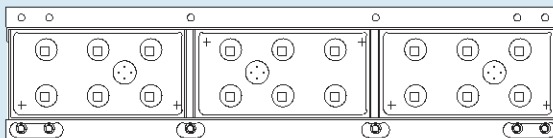

**2 Cell  
(17-33 plates)**

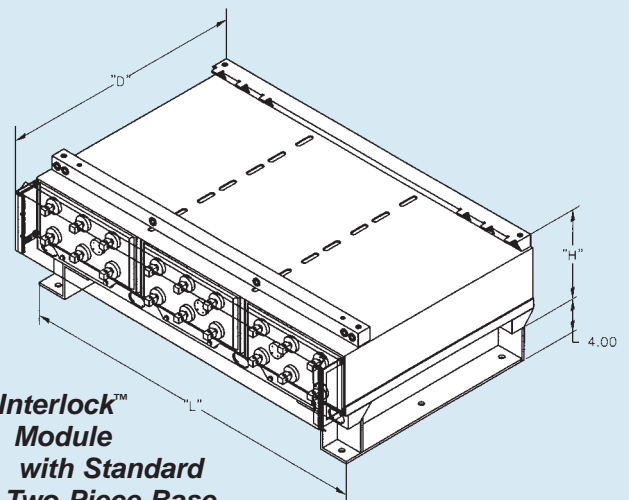
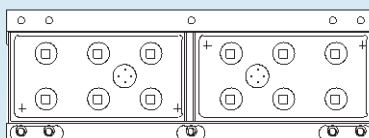

**Interlock™  
Module  
with Standard  
Two-Piece Base**

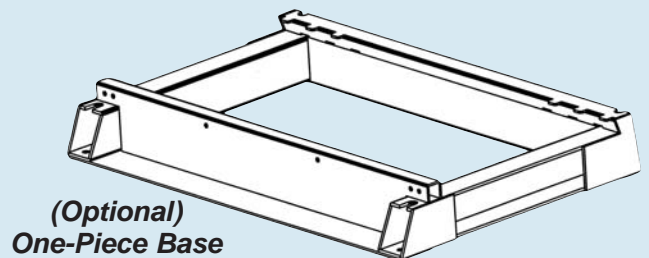

**(Optional)  
One-Piece Base**

## PRODUCT INFORMATION

**Container Material:** **Standard Polypropylene** – This material is typically used when there are no requirements for a flame retardant material. Add “S” suffix to module number when ordering. (ex. 6AVR95-07S)

**Flame Retardant Polypropylene** (Optional) – This material is a V-O halogenated polypropylene. This material has an LOI (Limiting Oxygen Index) of greater than or equal to 28%. Add “L” suffix to module number when ordering. (ex. 6AVR95-07L)

**Termination:** Top or side termination is available as a standard feature at no additional cost.

**Module Size:** There are various module sizes, a 6-cell module for 7 thru 15 plate cells and a 3-cell module for 17 thru 33 plate cells. These module sizes are our most popular configurations. For special space requirements, there are two additional sizes, a 4-cell module for 7 thru 15 plate cells and a 2-cell module for 17 thru 33 plate cells. It offers more choices in configuring the battery system, provides more flexibility when selecting height and length of your particular system configurations, and enhances overall space saving and versatility.

**Maximum Modules:** Modules can be stacked from one module high all the way up to eight modules high and still meet UBC 97 seismic zone 4 standards (using a one-piece base).

**Connector Package:** Our standard connector package meets discharge rates as low as the one hour rate to 1.75 vpc. Optional packages are available to provide the proper hardware for your higher rate applications.

**Base Support:** The standard base support is made up of two pieces, a left and a right side support. It is UBC 97 certified up to and including seismic zone 3 faultline. (For details on optional One-Piece base, see below.)



## OPTIONAL ACCESSORIES

**Top Mounting Plates for Electronics** – A plate used to bolt electronics on top of battery/system.

**System Current Shunt Kit** – A measuring device used to test/monitor the condition of the battery.

**High Voltage Buss Bar Kit** – Kit permits multiple battery strings to be connected for easy distribution to system connections.

**Floor Loading Plates** – Plate distributes load weight evenly.

**Disconnect Breaker Kit** – Kit turns battery on and off by opening the battery circuit.

**Optional One-Piece Base** – When seismic zone 4 is required, order the one-piece base support. This base is UBC 97 certified to meet seismic zone 4, top of building up to eight modules high of the largest AVR95-33 battery. This support also provides easier installation by not having to align two supports. Just bolt to the floor and start assembling the battery system.

*Shown at left:*  
**48-volt Deka Unigy II  
AVR95 Interlock™ System**

## EAST PENN manufacturing co., inc.

Lyon Station, PA 19536-0147 • Phone: 610-682-6361 • Fax: 610-682-4781

**Order Department Hotline: 610-682-4231**

WWW: <http://www.eastpenn-deka.com>

E-mail: [epmstat@eastpenn-deka.com](mailto:epmstat@eastpenn-deka.com)

E.P.M. Form No. 0975 9/02  
© 2002 by EPM Printed in U.S.A.

DISTRIBUTED BY: